

UNI 4 Air handling unit



Air handling unit suitable for larger residential and smaller commercial buildings.

A

700060, 700061, 700062, 700063

- Temperature efficiency in the heat recovery system up to 85%.
- Specific fan power (SFP) in the ventilation system lower than 1.5.
- Extremely quiet.
- Simple to operate, change filters and maintain.
- Provides balanced ventilation with an extremely good indoor climate.
- Option of communication by Modbus.
- Modern design.
- Efficient and reliable – even in the cold.

	GTIN	Model
700060	7023677000602	UNI 4 RER right model, EC fans, with electric element
700061	7023677000619	UNI 4 REL left model, EC fans, with electric element
700062	7023677000626	UNI 4 R R right model, EC fans, without element
700063	7023677000633	UNI 4 R L left model, EC fans, without element

Technical data

	UNI 4 RE	UNI 4 R
Rated voltage	230V 50Hz	230V 50Hz
Fuse size	10A	10A
Rated current, total	7,2 A	2,1 A
Rated power, total	1 655 W	355 W
Rated power, electric battery	1 300W	-
Rated power fans	175W x 2	175W x 2
Rated preheating power	-	-
Fan type	B-wheel	B-wheel
Fan motor control	0-10V	0-10V
Fan speed, max. rpm	2 930 rpm	2 930 rpm
Automatic control standard	CU60	CU60
Filter type (SUP/EXTR)	ePM1 55% (F7)	ePM1 55% (F7)
Filter dimensions (WxHxD)	459x207x31 mm	459x207x31 mm
Weight	86 kg	86 kg
Duct connection	Ø160 mm*	Ø160 mm*
Height	700 mm	700 mm
Width	900 mm	900 mm
Dybde	540 mm	540 mm

*Kitchen connection Ø125mm

Energy class:



CTRL 0,65

LOCAL DEMAND CONTROL

Sensor control for different zones

Accessories: Advanced panel + CO₂-sensor/motion sensor + damper

Result: Increased air flow rate in zones that need it

www.flexit.com

Dimensioned drawing

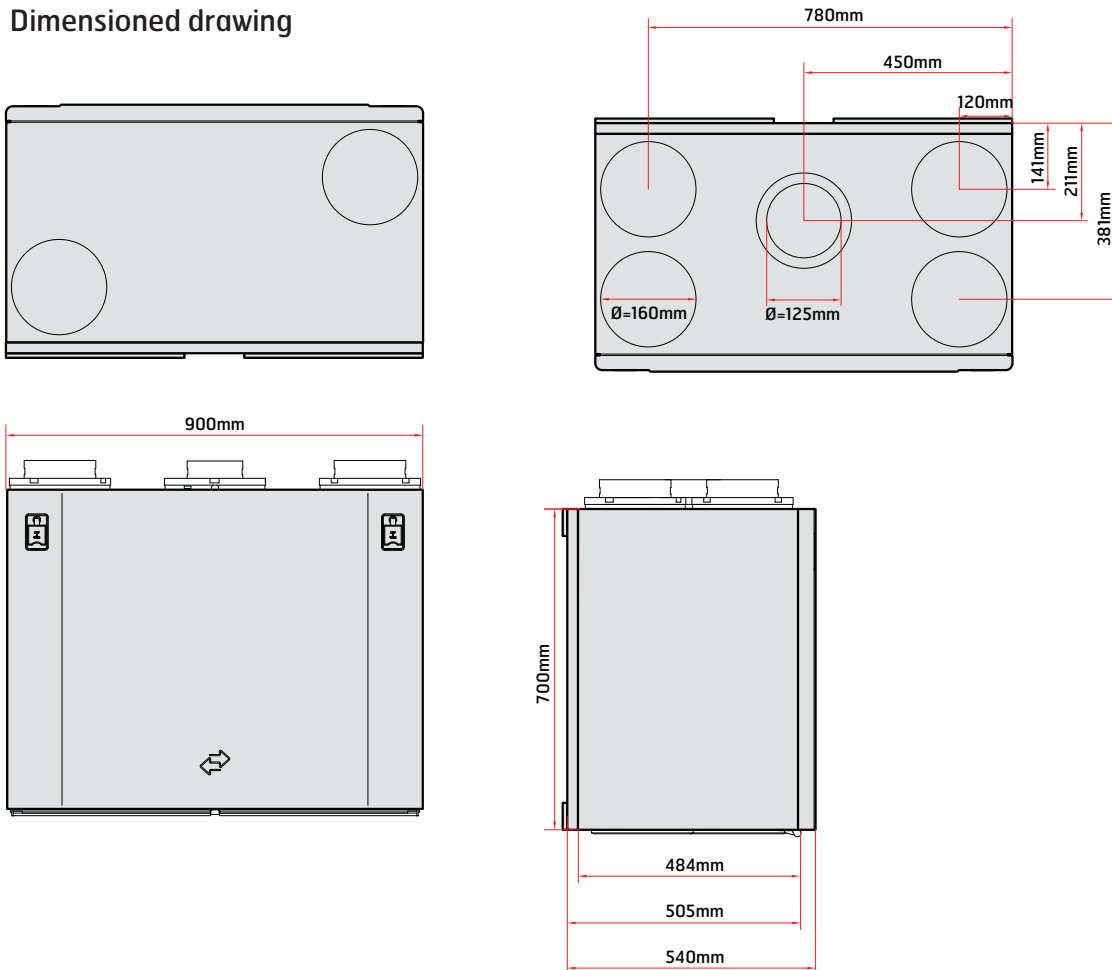

Capacity and sound data

Supply air side

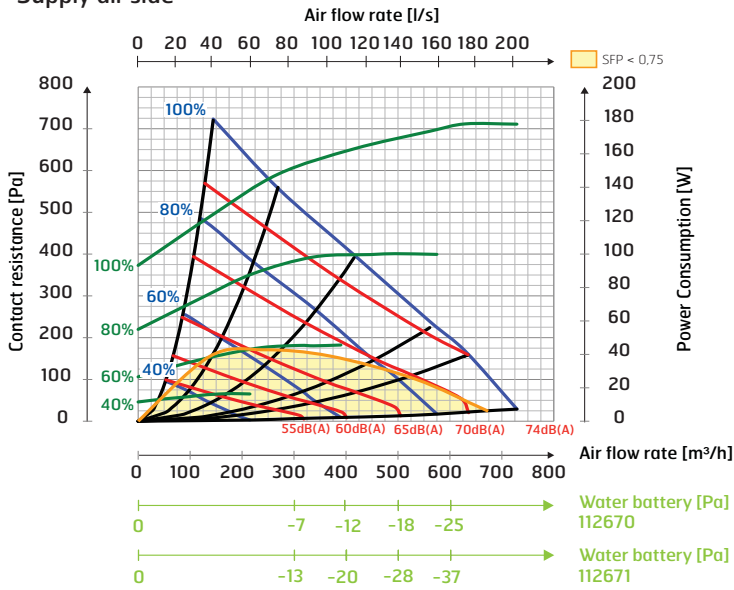

Extract air side

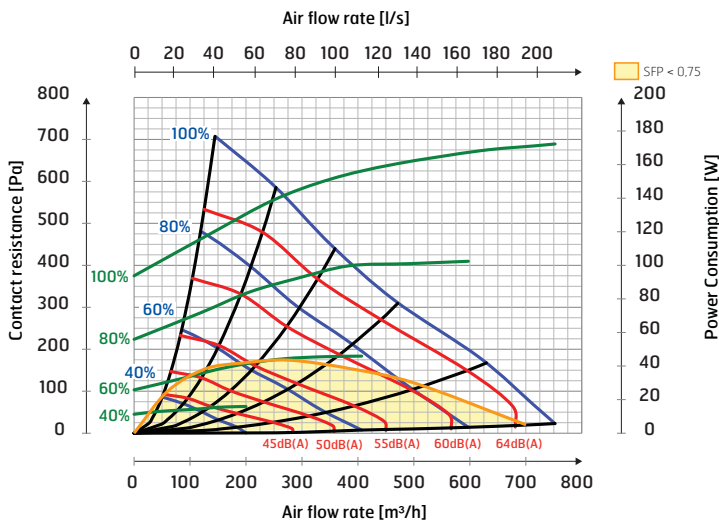

Correction factor for Lw

Hz	63 Lw(dB)	125 Lw(dB)	250 Lw(dB)	500 Lw(dB)	1000 Lw(dB)	2000 Lw(dB)	4000 Lw(dB)	8000 Lw(dB)	LwA (dBA)
Supply air	6	8	3	-3	-10	-14	-25	-29	
Extract air	9	8	3	-1	-13	-25	-35	-36	
Radiated	-17	-17	-13	-28	-34	-36	-43	-45	-21

Explanation of diagram

Sound data is stated as the sound output level LwA in the capacity diagrams (these are for sound to the duct).

These values can be corrected by means of the table for the different octave bands if it is wished to look at Lw (without adaptation to A band).

The correction table for the various octaves is stated in Lw, which means that the Lw values are after conversion of each octave for supply air and extract air.

Radiated sound from the unit must be calculated from the supply air diagram.

Position

The unit can be installed in the following ways:

1. On a wall (vertically and laterally). In this case the enclosed wall bracket is used for installation. Duct covers are available as accessories.
2. On the floor (horizontally on its back). In this case absorption feet are recommended (available as an accessory).

The unit is available in both left and right versions, depending on what best matches the duct location.

They can be located in a cold zone such as the loft.

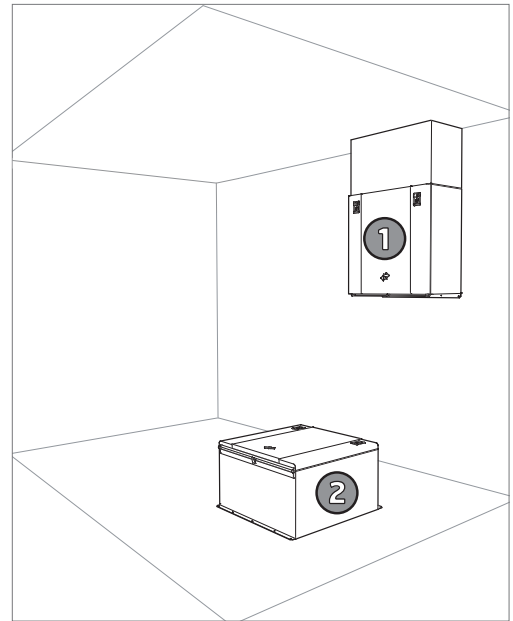

Duct location

Left-hand model top

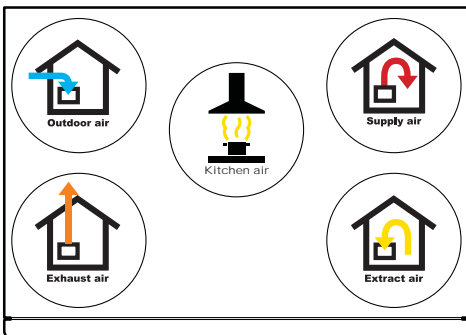

Right-hand model top



Left-hand model bottom

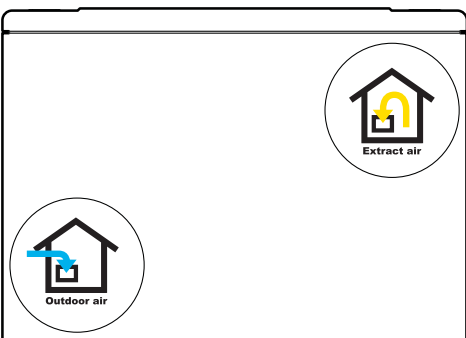

Right-hand model bottom

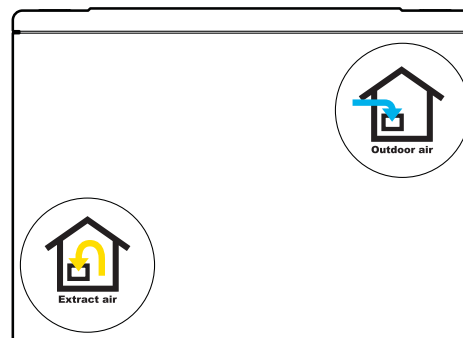

For more information on topics including installation, wiring diagrams and accessories, see www.flexit.com

Flexit AS

Tlf +47 69 81 00 00

post@flexit.no www.flexit.com

Our products are subject to continuous development and we therefore reserve the right to make changes. We also disclaim liability for any printing errors that may occur.